

**DENTAL CLINIC**

DESIGNED FOR PERFORMANCE

**SARATOGA** | sign

DESIGN

INNOVATION

ERGONOMICS

# Welcome to the Saratoga Dental Clinic Division



## Sign

Il progetto Sign nasce dall'idea di reinterpretare la gamma classica Saratoga secondo una filosofia ultra modulare, con l'obiettivo di offrire al professionista la possibilità di personalizzare il proprio arredo in base al gusto estetico, alle esigenze funzionali e al budget disponibile.

Frutto dell'implementazione dei principi della lean manufacturing, il progetto ha permesso a Saratoga di ottimizzare i flussi produttivi e di garantire una flessibilità senza precedenti nella configurazione dei propri mobili.

Il cuore del sistema è la monoscocca, che grazie all'ampia gamma di allestimenti e finiture disponibili può essere "vestita" come un abito su misura, con 256 combinazioni differenti per adattarsi perfettamente a ogni ambiente e stile.

Das Projekt Sign entstand aus der Idee, die klassische Saratoga-Kollektion nach einer ultramodularen Philosophie neu zu interpretieren. Ziel ist es, dem Benutzer die Möglichkeit zu geben, seine Einrichtung nach ästhetischem Geschmack, funktionalen Anforderungen und verfügbarem Budget individuell zu gestalten.

Durch die Umsetzung der Prinzipien der Lean Manufacturing konnte Saratoga die Produktionsabläufe optimieren und eine nie dagewesene Flexibilität bei der Möbelkonfiguration erreichen.

Kern des Systems ist die Monocoque-Struktur, die dank einer breiten Auswahl an Ausstattungen und Oberflächen wie ein maßgeschneidertes Kleid gestaltet werden kann – mit 256 verschiedenen Kombinationen, die sich perfekt an jeden Raum und Stil anpassen.

# Corporate Identity

Da oltre cinquant'anni, Saratoga è sinonimo di eccellenza nella produzione di arredi professionali per studi odontoiatrici, sale di sterilizzazione e laboratori odontotecnici, con una costante attenzione al design, all'ergonomia e alla funzionalità.

Lo stabilimento produttivo, che si estende su un'area di 15.000 m<sup>2</sup>, integra le più avanzate tecnologie per la lavorazione e la verniciatura dei mobili, garantendo standard qualitativi elevati in ogni fase del processo produttivo.

Dal 14 novembre 2002, l'azienda è certificata UNI EN ISO 9001, a conferma del suo impegno costante verso la qualità e il miglioramento continuo.

Seit über fünfzig Jahren steht Saratoga für höchste Qualität in der Herstellung von professionellen Einrichtungen für Zahnarztpraxen, Sterilisationsräume und zahntechnische Labors, mit einem aufmerksamen Blick auf Design, Ergonomie und Funktionalität.

Die Produktionsstätte, die sich über eine Fläche von 15.000 m<sup>2</sup> erstreckt, verfügt über modernste Technologien für die Fertigung und Lackierung der Möbel und garantiert höchste Qualitätsstandards in allen Produktionsphasen.

Seit dem 14. November 2002 ist das Unternehmen nach UNI EN ISO 9001 zertifiziert – ein Beweis für das stetige Engagement für Qualität und kontinuierliche Verbesserung.



# Matrix System



La scocca unica di SIGN può essere personalizzata in 256 diverse configurazioni ed è disponibile in tutti i colori RAL e ARC della gamma Saratoga. Ogni dettaglio è pensato per offrire la massima libertà compositiva:

**Tipologia di appoggio:** a terra, rialzato o sospeso

**Frontali:** in metallo, con o senza maniglia integrata, oppure in alluminio con maniglia integrata

**Piano di lavoro:** disponibile in Hi-Macs®, vetro da 12 mm, laminato o HPL

**E non solo:** rubinetti, lavelli, maniglie e una vasta selezione di accessori permettono di creare il mobile ideale, perfettamente in linea con lo stile e le esigenze di ogni professionista.

Die einzigartige SIGN-Konstruktion kann in 256 verschiedenen Konfigurationen gestaltet werden und ist in allen RAL- und ARC-Farben der Saratoga-Kollektion erhältlich. Jedes Detail wurde entwickelt, um maximale Gestaltungsfreiheit zu bieten:

**Unterstützungsart:** bodenstehend, erhöht oder wandhängend

**Fronten:** aus Metall mit oder ohne integrierten Griff, oder aus Aluminium mit integriertem Griff

**Arbeitsplatte:** Hi-Macs®, 12 mm Glas, Laminat oder HPL

**Und noch mehr:** Armaturen, Waschbecken, Griffe und eine große Auswahl an Zubehör ermöglichen die Gestaltung des perfekten Möbels, das Stil und Anforderungen jedes Fachmanns optimal erfüllt.



# SIGN B

I modelli Sign si adattano allo stile dell'ambiente e sono proposti in tre diverse configurazioni: fino a terra, rialzata e sospesa. Nella versione fino a terra è possibile scegliere tra la semplicità dello zoccolo e la praticità del cassettone.

Die SIGN Schränke passen sich zu dem Stil der Umgebung an, und sind in drei verschiedenen Varianten angeboten: bis zum Boden, mit Rahmen und Füßen, gehängt.



- Vasca integrata
- Integriertes Waschbecken



- Zoccolo in metallo
- Stahlsockel

**Piano di lavoro:**  
Hi-Macs® Alpine White  
**Frontali:**  
metallo

**Arbeitsplatte:**  
Hi-Macs® Alpine White  
**Fronten:**  
Stahl





# SIGN F

La versione rialzata si concretizza nell'utilizzo di un telaio unico in metallo con piedini oppure di un supporto dalla caratteristica forma "a slitta".

Diese Version gekennzeichnet sich für den Metall-Rahmen mit Füßen oder für die „Bügel-formigen“ Füßen.

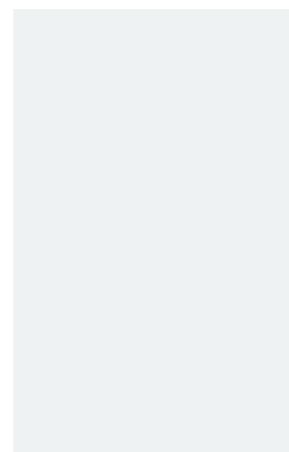

**Piano di lavoro:**  
Hi-Macs® Alpine White  
**Frontali:**  
Alluminio

**Arbeitsplatte:**  
Hi-Macs® Alpine White  
**Fronten:**  
Aluminium

- Frontale in alluminio con maniglia integrata
- Fronten aus Aluminium mit integriertem Griff





- *Alzatina integrata e raggiata, frontale da 12 mm raggiato*
- *Integrata und abgerundete Aufkantung, 12 mm abgerundete vordere Kante*



- *Supporto verniciato*
- *Abgerundete Halterung*



# SIGN S

Un elegante mobile sospeso che si contraddistingue per garantire la massima igiene: lo stile si lega alla funzionalità.

Eine elegante gehängte Zeile für die höchste mögliche Hygiene: Stil und Funktionalität.

**Piano di lavoro:**  
Hi-Macs® Alpine White  
**Frontali:**  
Metallo Fiery Red

**Arbeitsplatte:**  
Hi-Macs® Alpine White  
**Fronten:**  
Stahl Fiery Red

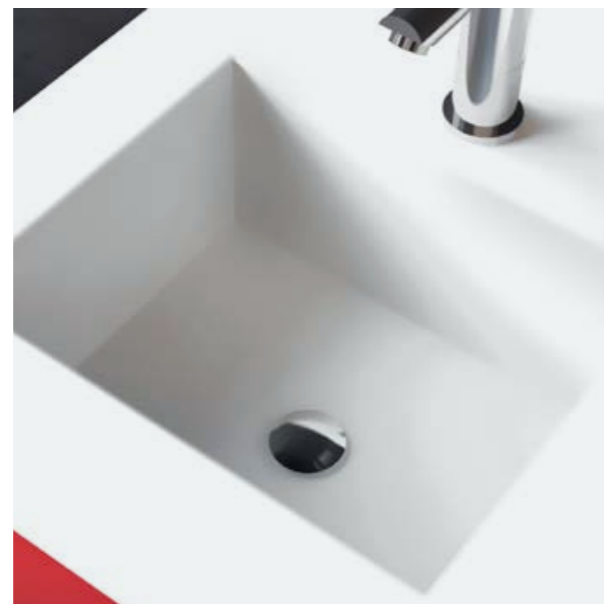

- Vasca rettangolare in Hi-Macs®
- Viereckiges Waschbecken aus Hi-Macs®



- Ante e cassetti senza maniglia integrata
- Türen und Schubladen ohne Griffe



# SIGN+ B

In tutte e tre le versioni l'elemento protagonista che connota la linea e firma il suo stile è il componente a slitta che disegna il mobile dal top a terra, lungo il suo profilo.

In diesen drei Versionen, Hauptdarsteller ist die "kugelförmige" Halterung, der die Linie auszeichnet und sie von Arbeitsplatte bis zum Boden gekennzeichnet.

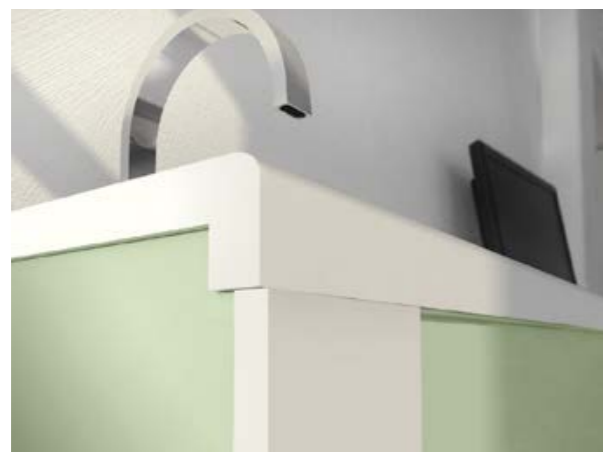

## Piano di lavoro:

Hi-Macs® Alpine White

## Frontali:

Alluminio

## Arbeitsplatte:

Hi-Macs® Alpine White

## Fronten:

Aluminium

• *Le superfici, le maniglie integrate, la continuità dei profili arrotondati, i fianchi integrati alla slitta in modo compatto sono concepiti per avere un'ottimale pulizia del mobile.*

• *Die Oberflächen, die integrierten Griffe, die abgerundeten Linien entwickelt für eine einfache und optimale Reinigung.*





Elegante e contemporanea, SIGN, nello stile delle linee Saratoga, si adatta con carattere e leggerezza ad ogni ambiente. La linea Sign può essere abbinata alle numerose vetrine e moduli igiene disponibili.

Stilvoll und modern, SIGN passt mit seinem Charakter und Leichtigkeit zu jeder möglichen Umgebung und zu der reichen Auswahl von Hängeschränke und Spendermodulen zusammen.

# SIGN+ F

La slitta è il vero tratto distintivo di ogni modello SIGN e può essere personalizzata nel colore.

Der Rotefaden der SIGN Linie ist die seitliche Halterung. Es ist möglich sie mit der Farbe zu personalisieren.

#### Piano di lavoro:

Hi-Macs® Alpine White

#### Frontali:

metallo

#### Arbeitsplatte:

Hi-Macs® Alpine White

#### Fronten:

Stahl



- *Vasca tonda integrata*
- *Integriertes abgerundete Waschbecken*



- *Piano in Hi-Macs® senza alzatina*
- *Hi-Macs® Arbeitsplatte ohne hintere Aufkantung*



# SIGN+ S

L'assenza di spigoli, i bordi arrotondati, le superfici complanari tra loro e la slitta che riprende lo stesso raggio di curvatura dal top all'appoggio a terra, donano leggerezza al mobile, che richiama un elegante stile vintage.

Das Fehlen von Kanten, die abgerundeten Ränder, die untereinander komplanaren Flächen und der Rahmen, der denselben Biegunsradius vor der Arbeitsplatte bis zur Auflage auf dem Boden übernimmt, verleihen dem Möbelstück sein leichtes Aussehen, das an einen eleganten Vintage-Stil erinnern.



- Piano raggiato
- Abgerundete Arbeitsplatte



- Frontali in metallo senza maniglia, apertura elettrica o meccanica
- Stahl-Fronten ohne Griff, elektrisch oder mechanisch betätigt.

**Piano di lavoro:**  
Hi-Macs® Alpine White  
**Frontali:**  
Metallo

**Arbeitsplatte:**  
Hi-Macs® Alpine White  
**Fronten:**  
Stahl



# Configurazioni ed accessori

Konfigurationen und Zubehör



# SIGN B

**SIGN B con carrello / mit trolley**

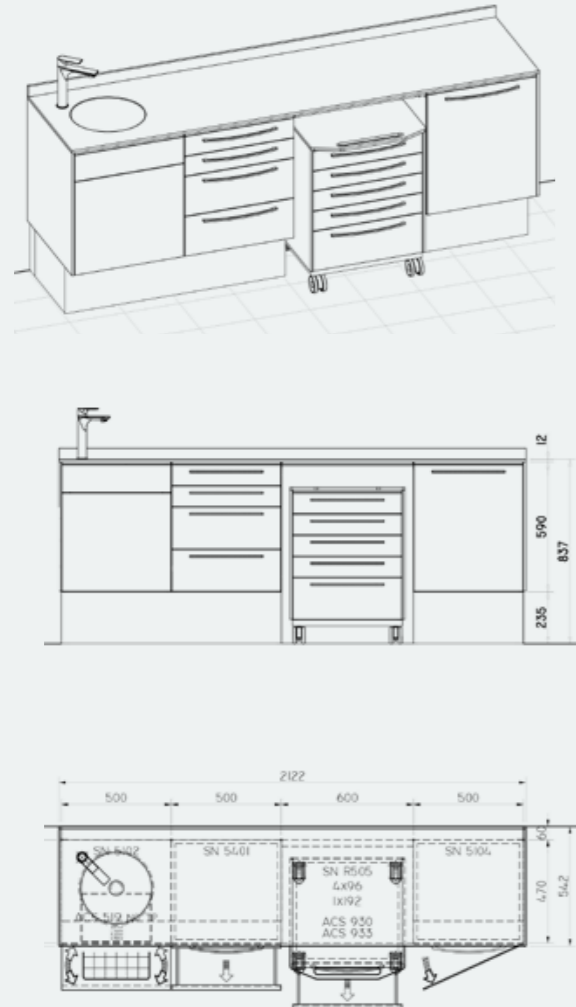

**SIGN B senza carrello / ohne trolley**

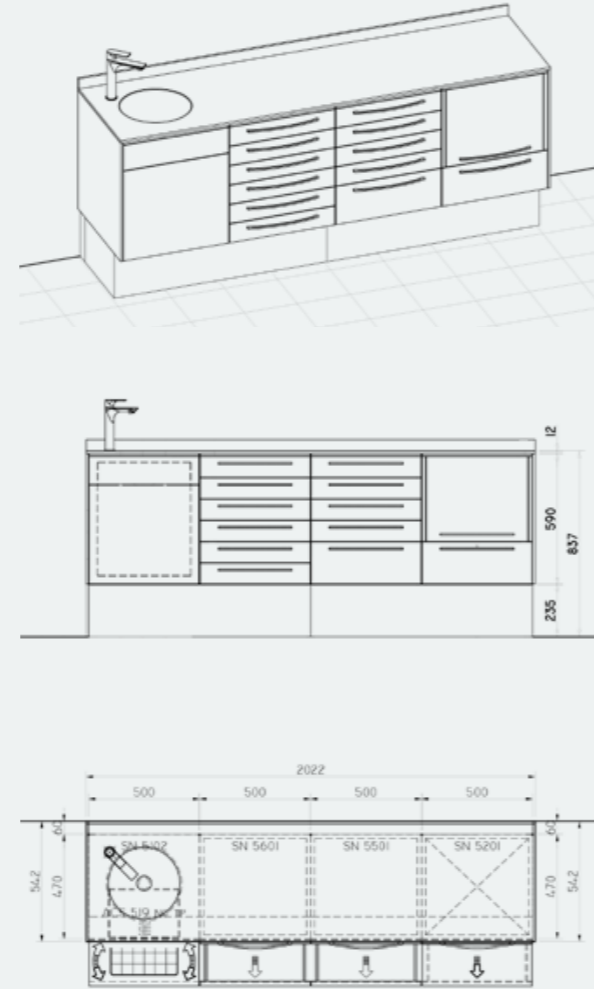

# SIGN+B

**SIGN+B con carrello / mit trolley**

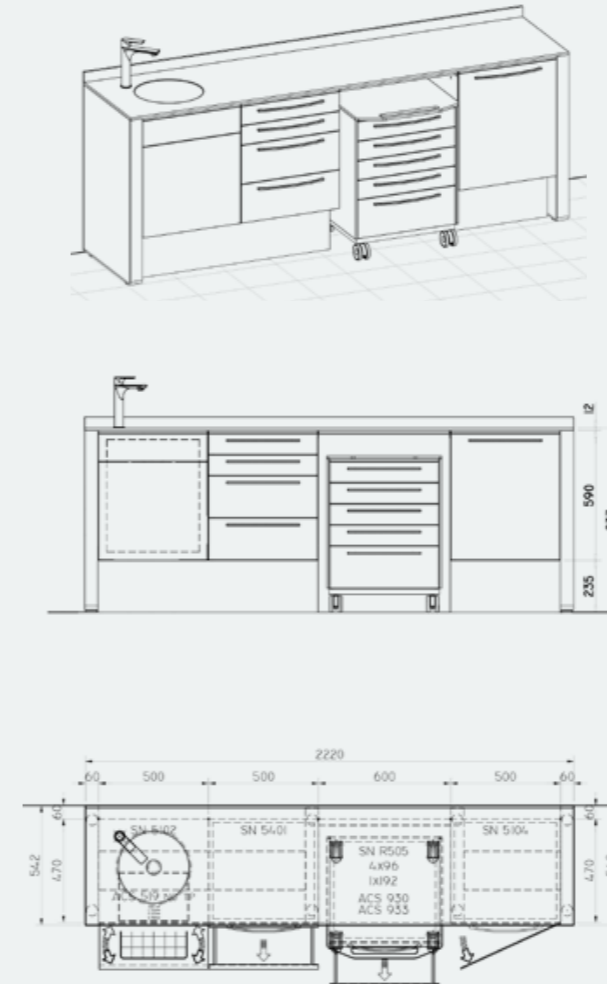

**SIGN+B senza carrello / ohne trolley**

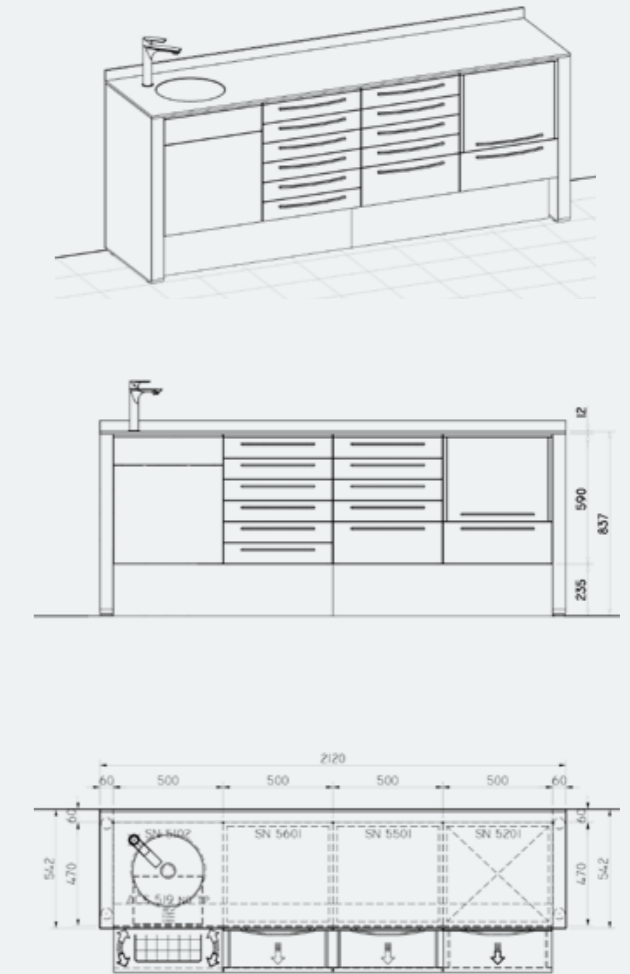

# SIGN F

**SIGN F con carrello / mit trolley**

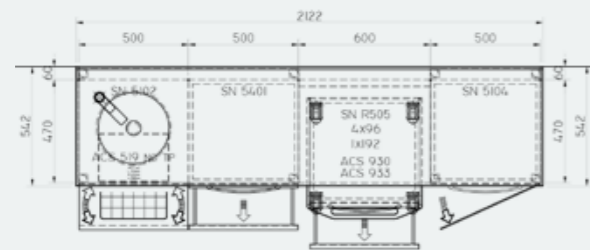
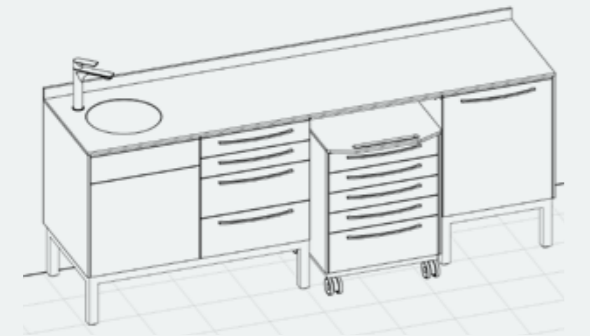

**SIGN F senza carrello / ohne trolley**

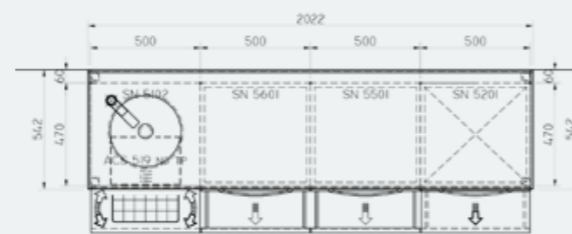
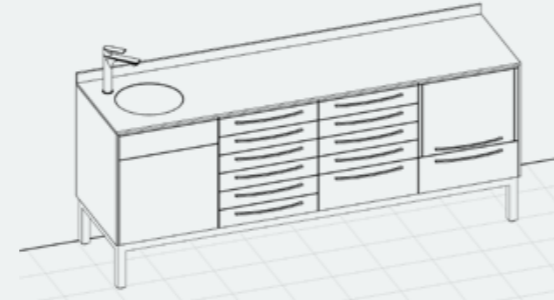

# SIGN+F

**SIGN+F con carrello / mit trolley**

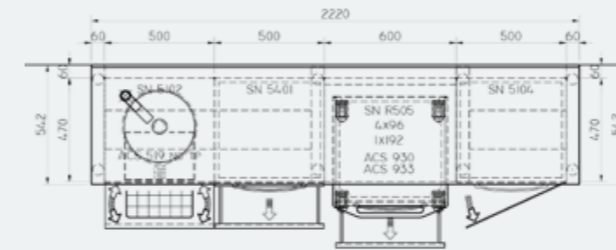
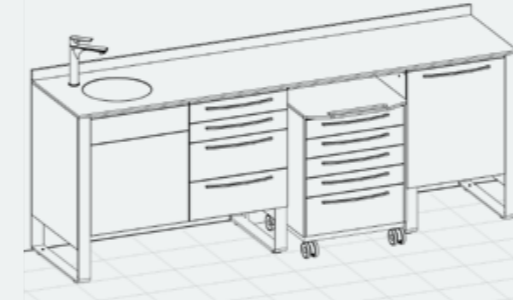

**SIGN+F senza carrello / ohne trolley**

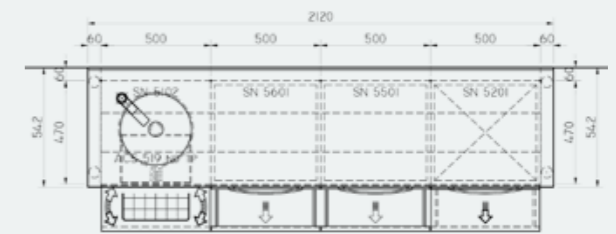
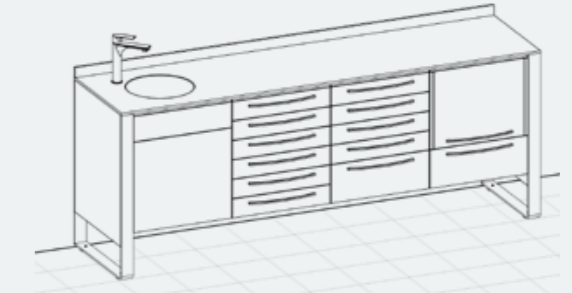

# SIGN S

**SIGN S** senza carrello / ohne trolley

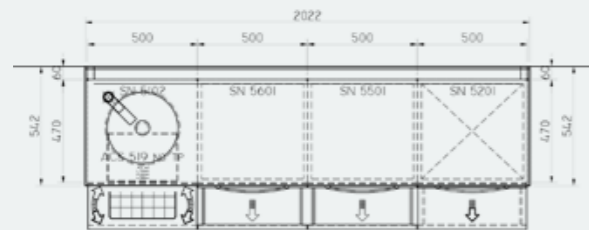
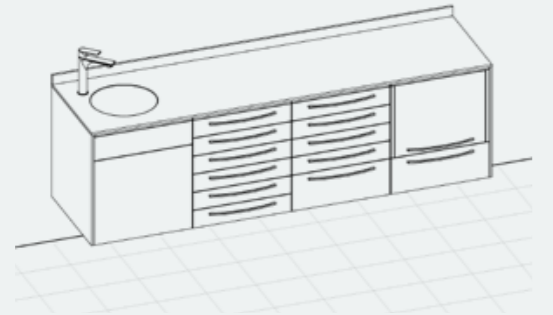

**SIGN S** senza carrello / ohne trolley

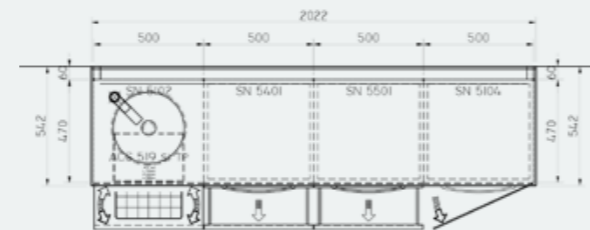
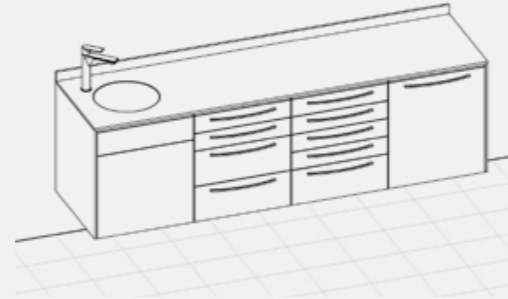

# SIGN+S

**SIGN+S** con carrello / mit trolley

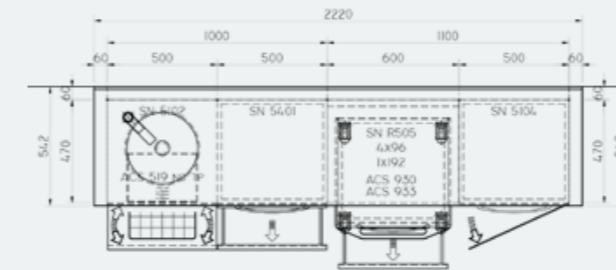
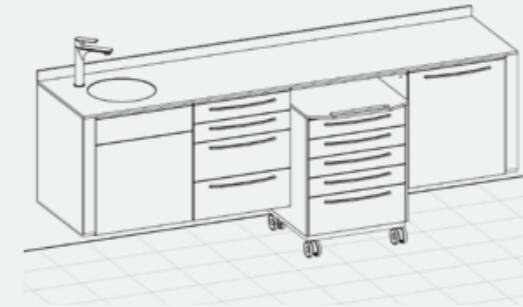

**SIGN+S** senza carrello / ohne trolley

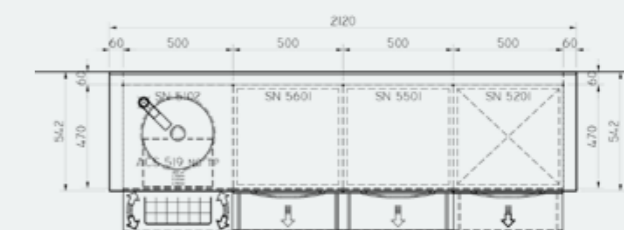
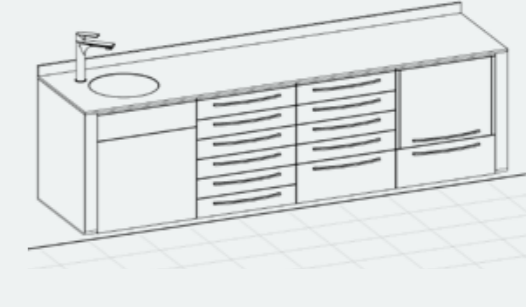

## INTERNI DEI CASSETTI / Schubladeneinsätze

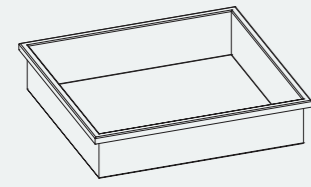

ACS 134/A

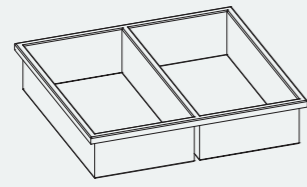

ACS 134/B

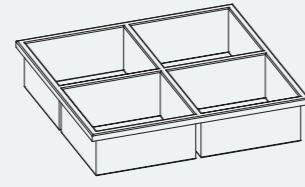

ACS 134/C

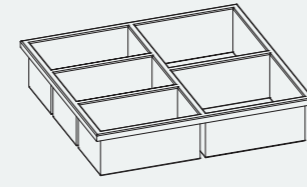

ACS 134/D

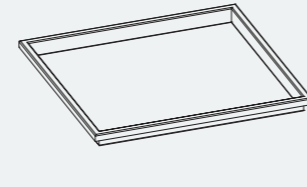

ACS 138/A

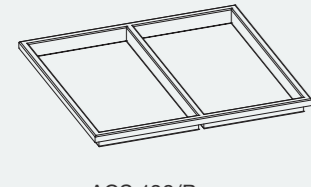

ACS 138/B

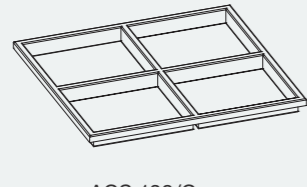

ACS 138/C

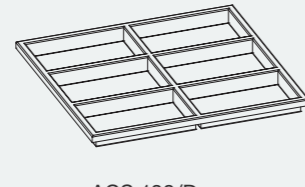

ACS 138/D

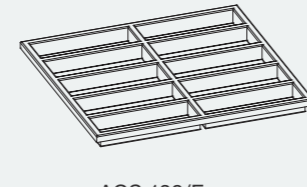

ACS 138/E

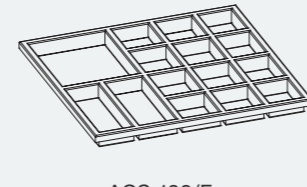

ACS 138/F

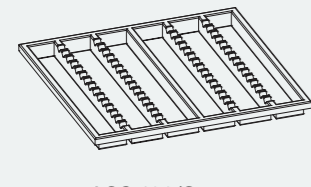

ACS 138/G



# RUBINETTI / Armaturen

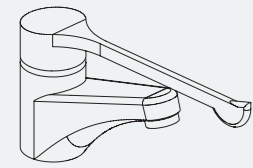

ACS 410

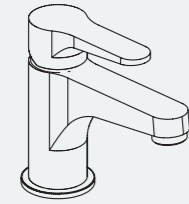

ACS 422

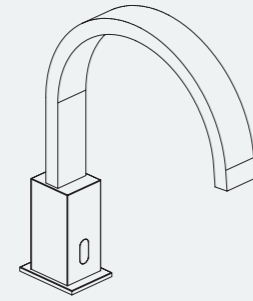

ACS 442

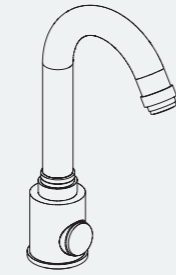

ACS 451B

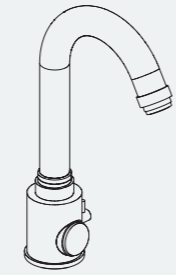

ACS 451C

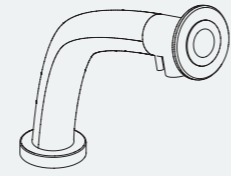

ACS 454

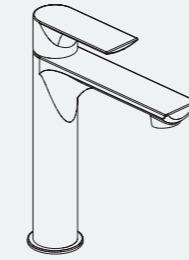

ACS 458C

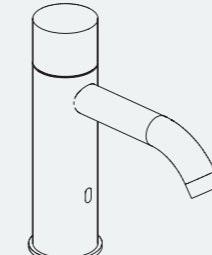

ACS 462

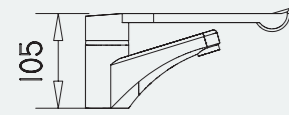

105

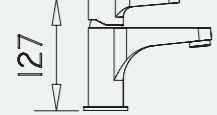

127

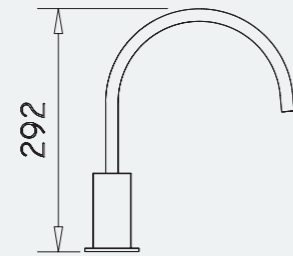

292

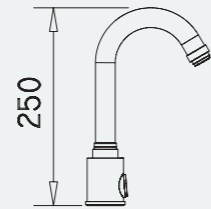

250

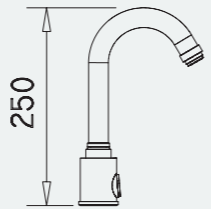

250

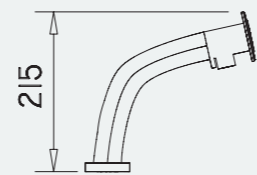

215

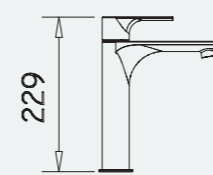

229

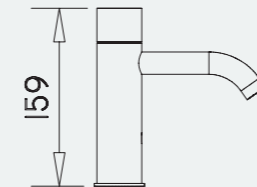

159

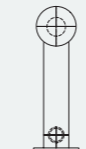
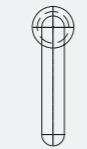
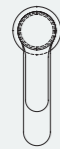



sign



SARATOGA S.R.L.  
VIA LUCIANO SAVIO, 7  
33170 PORDENONE, ITALIA

+39 0434 572600

[SARATOGADENTAL.IT](http://SARATOGADENTAL.IT)